

X200₂ Series Inverter Quick Reference Guide

- Single-phase Input 200V class
- Three-phase Input 200V class
- Three-phase Input 400V class



Hitachi Industrial Equipment Systems Co., Ltd.

Manual No. NT3041XA •Apr 2010



Caution: Be sure to read the X200z Manual and the X200z Manual Addendum, and follow their Cautions and Warnings for the initial product installation. This Quick Reference Guide is intended for reference use by experienced users in servicing existing installations.

Power Circuit Terminals

Inverter models X200-002SFEF2/NFU2, -004SFEF2/NFU2

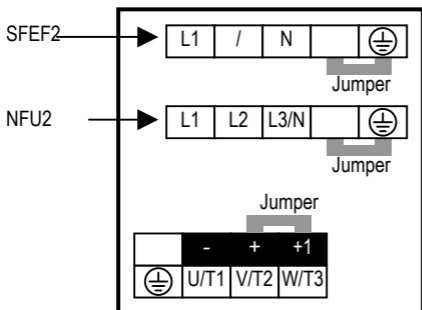

Inverter models X200-005SFEF2, -007SFEF2/NFU2 to -022SFEF2/NFU2, -037LFU2 to -075LFU2, 004HFEF2/HFU2 to -075HFEF2/HFU2

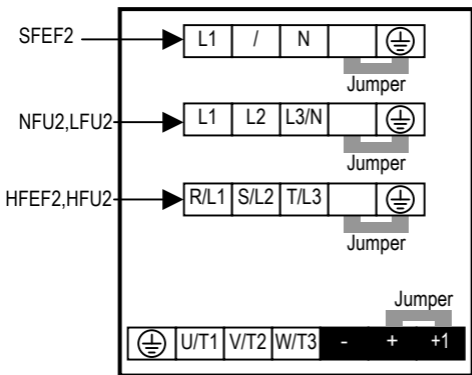

Caution: Power terminal assignment is different compared to old models such as L100, L200 series. Pay attention when wiring the power cable.

Control Circuit Terminals

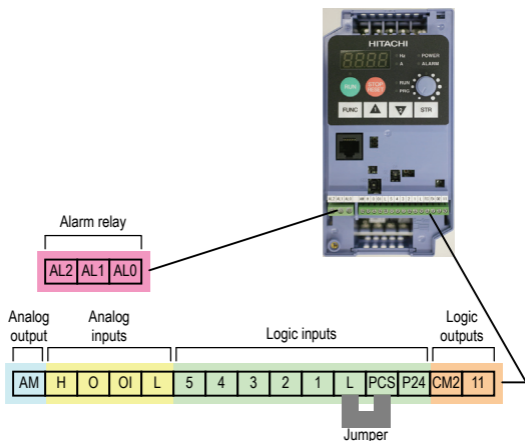

Terminal Name	Description	Ratings and Notes
P24	+24V for logic inputs	24VDC supply, 30mA max. (Notes: Do not use for network power. Do not short to terminal L)
1, 2, 3, 4, 5	Intelligent (programmable discrete logic) inputs	27VDC max. (Use P24 or an external supply reference to terminal L), 4.7kΩ input impedance.
11	Discrete logic output	50mA max. ON current, 27VDC max. OFF voltage
L (right)	GND for logic inputs	Sum of input 1 to 5 currents (Note: Do not ground)
CM2	Common for logic outputs	50mA max for terminal 11 current
AM	Analog voltage output	0 to 10VDC, 1mA max. ±10%(at25°C±10°C)
L (left)	Common for analog inputs	Sum of OI, O and H currents (return)
OI	Analog input, current	4 to 19.6mA range, 20mA nom.
O	Analog input, voltage	0 to 9.6VDC range, 10VDC nominal, 12VDC max., input impedance 10kΩ
H	+10V analog reference	10VDC nominal, 10mA max.
AL0	Relay common contact	Contact rating
AL1	Relay contact, normally closed during RUN	Max resistive load=250VAC, 2.5A; 30VDC 3A;
AL2	Relay contact, normally open during RUN	Max inductive load=250VAC, 0.2A; 30VDC 0.7A Minimum load=5VDC 100mA, 100VAC 10mA

Note) Analog input O and OI cannot be used at the same time.

Basic Wiring Diagram

The following wiring diagram shows the power and motor connections for basic operation. The optional signal input wiring supports external Fwd and Rev Run command, and a speed potentiometer.

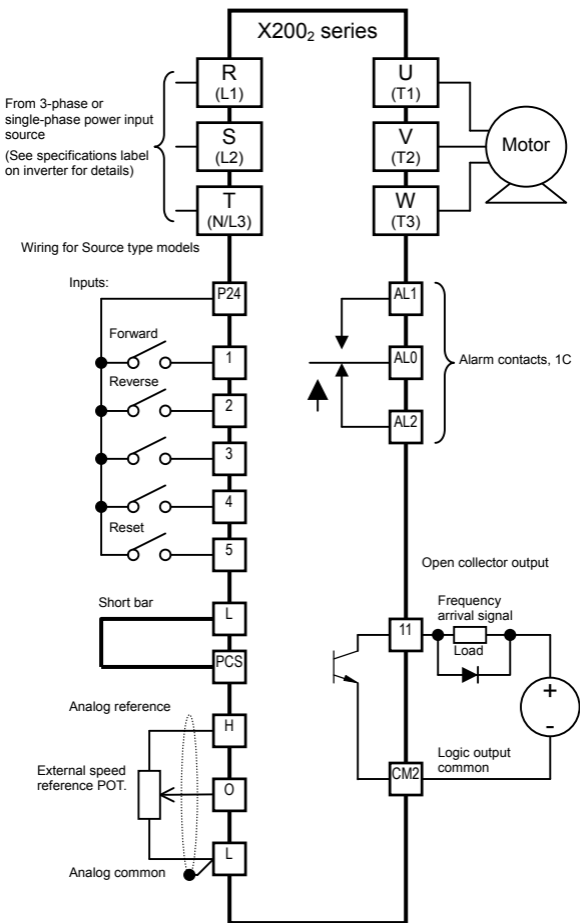

Inverter Keypad Operation

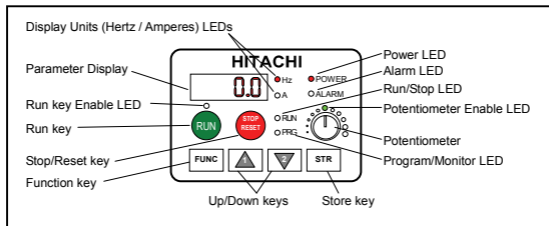

- **Run/Stop LED** – ON when the inverter output is ON and the motor is developing torque (Run Mode), and OFF when the inverter output is OFF (Stop Mode).
- **Program/Monitor LED** – This LED is ON when the inverter is ready for parameter editing (Program Mode). It is OFF when the parameter display is monitoring data (Monitor Mode).
- **Run Key Enable LED** – is ON when the inverter is ready to respond to the Run key, OFF when the Run key is disabled.
- **Run Key** – Press this key to run the motor (the Run Enable LED must be ON first). Parameter F004, Keypad Run Key Routing, determines whether the Run key generates a Run FWD or Run REV command.
- **Stop/Reset Key** – Press this key to stop the motor when it is running (uses the programmed deceleration rate). This key will also reset an alarm that has tripped.
- **Potentiometer** – Allows an operator to directly set the motor speed when the potentiometer is enabled for output frequency control.
- **Potentiometer Enable LED** – ON when the potentiometer is enabled for value entry.
- **Parameter Display** – A 4-digit, 7-segment display for parameters and function codes.
- **Display Units, Hertz/Amperes** – One of these LEDs will be ON to indicate the units associated with the parameter display.
- **Power LED** – This is ON when the power input to the inverter is ON.
- **Alarm LED** – ON when an inverter trip is active (alarm relay contact will be closed).
- **Function Key** – This key is used to navigate through the lists of parameters and functions for setting and monitoring parameter values.
- **Up/Down keys** – Use these keys alternatively to move up or down the lists of parameter and functions shown in the display, and increment/decrement values.
- **Store key** – When the unit is in Program Mode and you have edited a parameter value, press the Store key to write the new value to the EEPROM.

Keypad Navigation Map

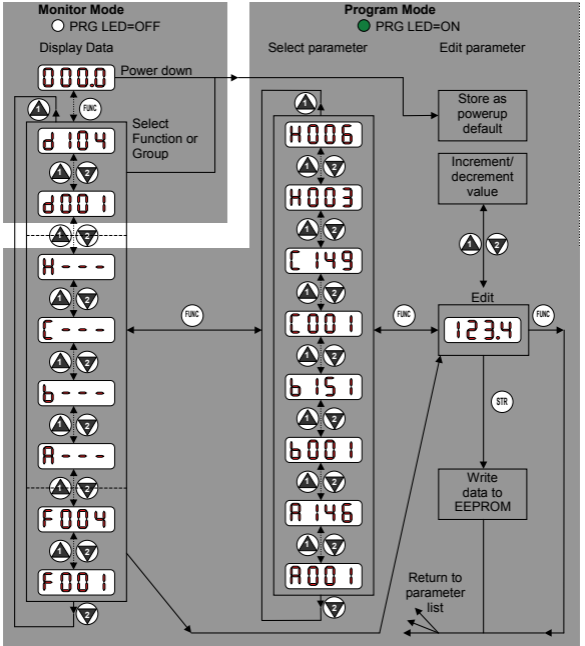

Powerup Test

The Powerup Test procedure uses minimal parameter settings to run the motor. The procedure describes two alternative methods for commanding the inverter: *via the inverter keypad, or via the logic terminals.*

- Check power input and motor output wiring (see page 3 diagram).
- If using logic terminals for testing, verify correct wiring on [PCS], [FW], [H], [O] and [L] (bottom row) per the diagram on page 3.
- Reverse [RV] input wiring (defaults to terminal [2]) is optional.

Step	Description	Via Keypad	Via Logic Terminals
1	Set speed command source setting	A001=00 (Keypad pot)	A001=01 [H·O·L] input
2	Set Run FW command source	A002=02 (Run key)	A002=01 [FW] input
3	Set Run REV command source	–	C002=01 (default) [RV] input
4	Set motor base freq.	A003=60	
5	Set motor poles	H004 = 4 (default), change only if your motor is different	
6	Set keypad display to monitor freq.	Access d001, press Func key, display will show 0.0	
		Disconnect load from motor	
7	Perform safety check	Turn keypad pot. To MIN position	Ensure voltage on [O] – [L] terminals = 0V
8	Run Forward command	Press Run key	Turn ON the [FW] terminal
9	Increase speed	Rotate keypad pot. CW direction	Increase voltage at [O]
10	Decrease speed	Rotate keypad pot. CCW direction	Decrease voltage at [O]
11	Stop motor	Press stop key	Turn OFF the [FW] terminal
12	Run Reverse command (optional)	–	Turn ON the [RV] terminal
13	Stop motor	–	Turn OFF the [RV] terminal

Error Codes



The X2002 series inverters will trip on over-current, over-voltage, and under-voltage to protect the inverter. The motor output turns OFF, allowing the motor to free-run to a stop. Press the Stop/Reset key to reset the inverter and clear the error.

Basic Error Codes

















Error Code	Name	Probable Cause(s)
E_01	Over current event while at constant speed	<ul style="list-style-type: none"> • Inverter output was short-circuited • Motor shaft is locked
E_02	Over current event during deceleration	<ul style="list-style-type: none"> • Load is too heavy • A dual voltage motor is wired incorrectly Note: The X200 will over-current trip at nominally 200% of the rated current.
E_03	Over current event during acceleration	
E_04	Over current event for other conditions	
E_05	Overload protection	<ul style="list-style-type: none"> • DC braking power (A_54) set too high • Current transformer / noise error
E_07	Over voltage protection	<ul style="list-style-type: none"> • DC bus voltage exceeds a threshold, due to regeneration energy from the motor
E_08	EEPROM error	<ul style="list-style-type: none"> • Built-in EEPROM memory experienced noise, high temperature, operating switch S8 before the display goes off at power off etc.
E_09	Under voltage error	<ul style="list-style-type: none"> • DC bus voltage decreased enough to cause a control circuit fault • Instantaneous power failure occurred
E_11	CPU error	<ul style="list-style-type: none"> • Built-in CPU had internal error
E_12	External trip	<ul style="list-style-type: none"> • [EXT] input signal detected
E_13	USP (Unattended Start Protection)	<ul style="list-style-type: none"> • When (USP) was enabled, an error occurred when power was applied while a Run signal was present
E_14	Ground fault	<ul style="list-style-type: none"> • A ground fault was detected between the inverter output and the motor. This feature protects the inverter, and does not protect humans.
E_15	Input over-voltage	<ul style="list-style-type: none"> • Input voltage was higher than the specified value, 100 sec. after powerup
E_21	Inverter thermal trip	<ul style="list-style-type: none"> • Inverter internal temperature is above the threshold
E_30	Driver error	Refer to E_01~E_04
E_35	Thermistor	<ul style="list-style-type: none"> • Thermistor input, [5] and [L] is over the temperature threshold
E_37	Safe stop	<ul style="list-style-type: none"> • Safe stop function is activated.
E_60	Communications error	<ul style="list-style-type: none"> • Communication error on RS485 MODBUS communication
- - -	Under-voltage (brownout) with output shutoff	<ul style="list-style-type: none"> • Low input voltage caused the inverter to turn OFF the motor output and try to restart. If unsuccessful, a trip occurs.

Error Trip Conditions

Use function code d081 to access the error trip conditions for the current error as shown in the table below. Use the Up and Down arrow keys to scroll through the trip condition parameters.

Step	Display
1. Access d081	d081
2. Press Function Key	If no error: _ _ _
	If error exists: E_xx (error code)
3. Press Up/Dn key (if error exists)	Output frequency at trip point: 48.50 Motor current at trip point: 10.3  DC bus voltage at trip point: 189.5  Cumulative Run hours at trip point: 15 Cumulative power-ON hours at trip point: 18

Restoring Factory Default Settings

Action	Display	Function/Parameter
Press  ,  or  as needed	b- - -	"B" Group selected
Press 	b001	First "B" Group parameter
Press/hold  until...	b085	Country code for initialization selected
Press  . If setting is correct, then skip next step.	02	00 = Japan 01 = Europe 02 = United States
To change country code, press  or  to set;  to store.		
Press 	b085	Country code for initialization selected
Press 	b084	Initialization function selected
Press 	00	00 = disable initialization
Press 	01	01 = enable initialization
Press 	b084	Initialization now enable to restore all defaults
Press/hold  ,  and  keys. Do not release yet.	b084	First part of key sequence
When your country code appears in the display, release all the keys.	EU USA JP	Default parameter country code shown during initialization
Initialization is complete.	d001	Function code for output frequency monitor shown



Note: After initializing the inverter, use the Powerup Test on page 6 to get the motor running again.

Parameter Tables

“D” group: Monitoring Functions

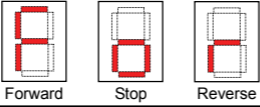
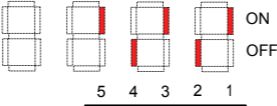
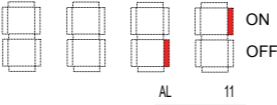
Func. Code	Name / Description	Units
D001	Output frequency monitor	Hz
D002	Output current monitor	A
D003	Rotation direction monitor  Forward Stop Reverse <hr/> Direction	–
D004	Process variable (PV), PID feedback monitor	%
D005	Intelligent input terminal status  ON OFF 5 4 3 2 1 <hr/> Terminal Numbers	–
D006	Intelligent output terminal status  ON OFF AL 11 <hr/> Terminal Numbers	–
D007	Scaled output frequency monitor (output frequency * b086 scale factor)	User-defined
D013	Output voltage monitor	V
D016	Cumulative operation RUN time monitor	hr
D017	Cumulative power-ON time monitor	hr
D018	Cooling fin temperature monitor	°C
D080	Trip counter	–
D081	Trip monitor 1 (most recent trip n)	–
D082	Trip monitor 2 (trip n-1)	–
D083	Trip monitor 3 (trip n-2)	–
D102	DC bus voltage monitor	V
D104	Electronic thermal monitor	%

Trip History and Inverter Status

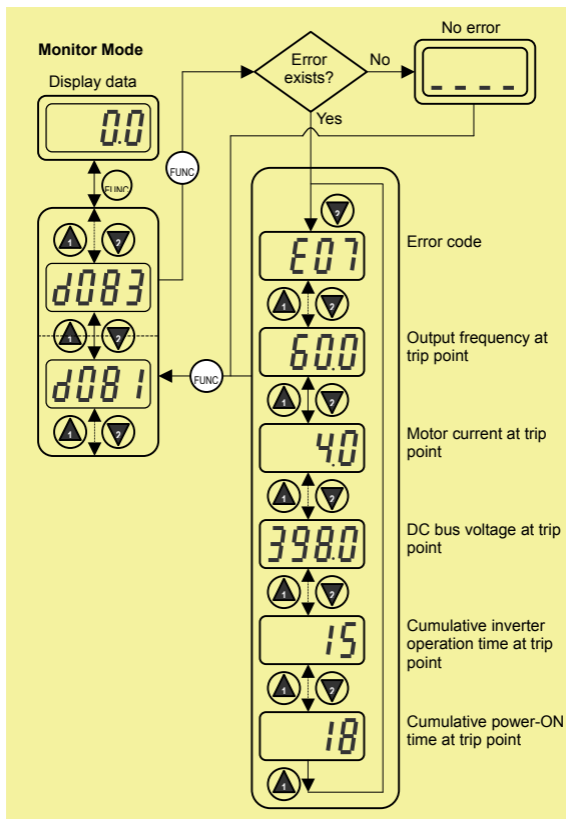

Parameter tables for user-settable functions follow these conventions:

- Some parameters have 2nd motor equivalents, indicated by the x2xx parameter codes in the left-most column.
- Some parameters specify an option code. Where applicable, the option codes will be in a bulleted list in the Name/Description column.
- The default values apply to all models unless otherwise noted for each parameter... -FE (Europe) / -FU (U.S.) / -FR (Japan).
- Some parameters cannot be edited during Run Mode, and certain Software Lock settings (b031) can prohibit all edits. If in doubt, place the inverter in Stop Mode or Consult the inverter manual for details.

“F” group: Main Profile Parameters

Func. Code	Name / Description	Default value -FEF2/FU2	Set value
F001	Output frequency setting	0.0	
F002	Acceleration (1) time setting	10.0	
F202	Acceleration (1) time setting <2 nd motor>	10.0	
F003	Deceleration (1) time setting	10.0	
F203	Deceleration (1) time setting <2 nd motor>	10.0	
F004	Keypad Run key routing • 00 Forward • 01 Reverse	00	

“A” group: Standard Functions

Func. Code	Name / Description	Default FEF2-FU:	Set value																											
A001/ A201	Frequency source setting • 00 Keypad potentiometer • 01 Control terminal • 02 Function F_01 setting • 03 RS485 Modbus communication • 10 Calculate function output	01/00																												
A002/ A202	Run command source setting • 01 Input terminal FW or RV (assignable) • 02 RUN key on the keypad • 03 RS485 Modbus communication	01/00																												
A003/ A203	Base frequency setting	50/60																												
A004/ A204	Maximum frequency setting	50/60																												
A005	[AT] selection • 02 Select [O] or POT by [AT] terminal input • 03 Select [OI] or POT by [AT] terminal input • 04 [O] input only • 05 [OI] input only	02																												
	<table border="1"> <thead> <tr> <th>A005</th> <th colspan="2">02</th> <th colspan="2">03</th> <th colspan="2">04</th> <th colspan="2">05</th> </tr> </thead> <tbody> <tr> <td>AT input</td> <td>OFF</td> <td>ON</td> <td>OFF</td> <td>ON</td> <td>OFF</td> <td>ON</td> <td>OFF</td> <td>ON</td> </tr> <tr> <td>Active</td> <td>[O]</td> <td>POT</td> <td>[OI]</td> <td>POT</td> <td colspan="2">[O]</td> <td colspan="2">[OI]</td> </tr> </tbody> </table>	A005	02		03		04		05		AT input	OFF	ON	OFF	ON	OFF	ON	OFF	ON	Active	[O]	POT	[OI]	POT	[O]		[OI]			
A005	02		03		04		05																							
AT input	OFF	ON	OFF	ON	OFF	ON	OFF	ON																						
Active	[O]	POT	[OI]	POT	[O]		[OI]																							
	Not assigned [AT] is the same as [AT]=OFF.																													
A011	O-L input active range start frequency	0.0																												
A012	O-L input active range end frequency	0.0																												
A013	O-L input active range start voltage	0.																												
A014	O-L input active range end voltage	100.																												
A015	O-L input start frequency enable • 00 Use A011 (starting value) • 01 Use 0Hz	01																												
A016	External frequency filter time constant	8.																												
A020/ A220	Multi-speed frequency setting	0.0																												
A021~ A035	Multi-speed frequency settings (for both motors)	0.0																												
A038	Jog frequency setting	1.0																												
A039	Jog stop mode • 00 Free-run stop, jogging disabled during motor run • 01 Controlled deceleration, jogging disabled during motor run • 02 DC braking to stop, jogging disabled during motor run	00																												
A041/ A241	Torque boost method selection • 00 Manual torque boost • 01 Automatic torque boost	00																												
A042/ A242	Manual torque boost value	1.8(A042)/ 0.0(A242)																												
A043/ A243	Manual torque boost frequency adjustment	10.0(A043)/ 0.0(A243)																												
A044/ A244	V/f characteristic curve selection • 00 V/f constant torque • 01 V/f variable torque • 06 V/f variable torque1	00																												

Func. Code	Name / Description	Default FEP2-FU:	Set value
A045/ A245	V/f gain setting	100.	
A051	DC braking enable • 00 Disable • 01 Enable • 02 Freq.detection	00	
A052	DC braking frequency setting	0.5	
A053	DC braking wait time	0.0	
A054	DC braking force during deceleration	0.	
A055	DC braking time for deceleration	0.0	
A056	DC braking / edge or level detection for [DB] input • 00 Edge • 01 Level	01	
A061/ A261	Frequency high limit setting	0.0	
A062/ A262	Frequency low limit setting	0.0	
A063 A065 A067	Jump (center) frequency setting	0.0	
A064 A066 A068	Jump (hysteresis) frequency width setting	0.5	
A071	PID enable • 00 PID operation OFF • 01 PID operation ON	00	
A072	PID proportional gain	1.0	
A073	PID integral time constant	1.0	
A074	PID derivative time constant	0.00	
A075	PV scale conversion	1.00	
A076	PV source setting • 00 [OI] terminal (current input) • 01 [O] terminal (voltage input) • 02 ModBus network • 03 Calculate function output	00	
A077	Reverse PID action • 00 PID input = SP-PV • 01 PID input = -(SP-PV)	00	
A078	PID output limit	0.0	
A081	AVR function select • 00 AVR enabled • 01 AVR disabled • 02 AVR enabled except during decel.	00	
A082	AVR voltage select	230,400/ 230,460	
A085	Operation mode selection • 00 Normal operation • 01 Energy-saver operation	00	
A086	Energy saving mode tuning	50.0	
A092/ A292	Acceleration (2) time setting	15.0	
A093/ A093	Deceleration (2) time setting	15.0	
A094/ A294	Select method to switch to Acc2/Dec2 profile • 00 2CH input from terminal • 01 transition frequency	00	
A095/ A295	Acc1 to Acc2 frequency transition point	0.0	
A096/ A296	Dec1 to Dec2 frequency transition point	0.0	

Func. Code	Name / Description	Default FEP2-FU:	Set value
A097	Acceleration curve selection • 00 Linear • 01 S-curve	00	
A098	Deceleration curve selection • 00 Linear • 01 S-curve	00	
A101	[OI]-[L] input active range start frequency	0.0	
A102	[OI]-[L] input active range end frequency	0.0	
A103	[OI]-[L] input active range start current	0.	
A104	[OI]-[L] input active range end current	100.	
A105	[OI]-[L] input start frequency enable • 00 Use A101 (starting value) • 01 Use 0Hz	01	
A141	Input A select for calculate function • 00 Integrated operator • 01 Keypad POT • 02 [O] input • 03 [OI] input • 04 Network variable	01	
A142	Input A select for calculate function • 00 Integrated operator • 01 Keypad POT • 02 [O] input • 03 [OI] input • 04 Network variable	02	
A143	Calculation symbol • 00 ADD (A + B) • 01 SUB (A - B) • 02 MUL (A * B)	00	
A145	ADD frequency	0.0	
A146	ADD direction select • 00 Plus (adds A145 value to output freq.) • 01 Minus (subtracts A145 value from output freq.)	00	
A151	POT active range start frequency	0.0	
A152	POT input active range end frequency	0.0	
A153	POT input active range start	0.	
A154	POT input active range end	100.	
A155	POT input start frequency enable	01	

“B” group: Fine-tuning Functions

Func. Code	Name / Description	Default FEF2/FU	Set value
B001	Selection of automatic restart mode • 00 Alarm output after trip, automatic restart disable • 01 Restart at 0Hz • 02 Resume operation after frequency pull-in • 03 Resume previous freq. after freq. pull-in, then decelerate to stop and display trip info	00	
B002	Allowable under-voltage power failure time	1.0	
B003	Retry wait time before motor restart	1.0	
B004	Instantaneous power failure / under-voltage trip alarm enable • 00 Disable • 01 Enable	00	
B005	Number of restarts on power failure / under-voltage trip event • 00 Restarts 16 times • 01 Always restart	00	
B011	Start freq to be used in case of freq pull-in restart • 00 Freq at previous shutoff • 01 Start from max. Hz • 02 Start from set freq	00	
B012/ B212	Level of electronic thermal setting	INV Rated current	
B013/ B213	Electronic thermal characteristics • 00 Reduced torque • 01 Const. torque	01	
B021/ B221	Overload restriction operation mode • 00 Disabled • 01 Enabled for accel and constant speed • 02 Enabled for constant speed only	01	
B022/ B222	Overload restriction level setting	INV Rated current x 1.5	
B023/ B223	Deceleration rate at overload restriction	1.0/30.0	
B028/ B228	Source of restriction selection • 00 set value of B022 • 01 [O] input	00	
B029	Deceleration rate of freq pull-in restart setting	0.5	
B030	Current level of freq pull-in restart setting	INV Rated current	
B031	Software lock mode selection • 00 Low-level access, [SFT] blocks edits • 01 Low-level access, [SFT] blocks edits (except F001 and Multi-speed parameters) • 02 No access to edits • 03 No access to edits (except F001 and Multi-speed parameters) • 10 High level access	01	
B050	Selection of the non stop operation • 00 Disable • 01 Enable(stop) • 02 Enable(restart)	00	
B051	Non stop operation start voltage setting	0.0	
B052	OV-LAD Stop level of non stop operation setting	0.0	
B053	Deceleration time of non stop operation setting	1.0	
B054	Frequency width of quick deceleration setting	0.0	
B055	DC bus AVR P-gain	0.2	
B056	DC bus AVR I-time	0.2	
B080	[AM] analog signal gain	100.	
B082	Start frequency adjustment	0.5	

Func. Code	Name / Description	Default FEF2/FU	Set value
B083	Carrier frequency setting	3.0	
B084	Initialization mode (parameter or trip history) • 00 Trip history clear • 01 Parameter initialization • 02 Trip history clear and parameter initialization	00	
B085	Country code for initialization • 00 Japan version • 01 Europe version • 02 US version	01/02	
B086	Frequency scaling conversion factor	1.0	
B087	STOP key enable • 00 Enable • 01 Disable	00	
B088	Restart mode after FRS • 00 Restart from 0Hz • 01 Restart with frequency pull-in	00	
B089	Data select for digital operator OPE-J • 01 Output frequency (d001) • 02 Output current (d002) • 03 Motor direction (d003) • 04 PID PV feedback (d004) • 05 Input status for input terminals (d005) • 06 Output status for output terminals (d006) • 07 Scaled output frequency (d007)	01	
B091	Stop mode selection • 00 DEC (decelerates and stop) • 01 FRS (free-run to stop)	00	
B092	Cooling fan control • 00 Fan is always ON • 01 Fan is ON during run, OFF during stop (5 minutes delay from ON to OFF) • 02 Fan is temperature controlled	00	
B130	Over-voltage LADSTOP enable • 00 Disable • 01 Enable	00	
B131	Over-voltage LADSTOP level	380,760	
B133	DC bus AVR selection • 00 Disable • 01 Enable	00	
B134	Threshold voltage of DC bus AVR setting	380,760	
B140	Over-current trip suppression • 00 Disable • 01 Enable	00	
B150	Automatic carrier control • 00 Disable • 01 Enable	00	
B151	Selection of RDY function	00	

“C” group: Intelligent Terminal Functions

Func. Code	Name / Description		Default value -FEF2/-FU2	Set value
C001/ C201	Terminal [1] function	Thirty one option codes available (See page 20)	00	
C002/ C202	Terminal [2] function		01	
C003/ C203	Terminal [3] function		02/16	
C004/ C204	Terminal [4] function		03/13	
C005/ C205	Terminal [5] function		18	
C011	Terminal [1] active state	<ul style="list-style-type: none"> • 00 Normally open [NO] • 01 Normally closed [NC] 	00	
C012	Terminal [2] active state		00	
C013	Terminal [3] active state		00	
C014	Terminal [4] active state		00/01	
C015	Terminal [5] active state		00	
C021	Terminal [11] function	Twelve option codes available (See page 20)	01	
C026	Relay output function	Twelve option codes available (See page 20)	05	
C028	AM signal selection • 00 motor speed • 01 motor current		00	
C031	Terminal [11] active state	<ul style="list-style-type: none"> • 00 Normally open [NO] • 01 Normally closed [NC] 	00	
C036	Alarm relay terminal active state		01	
C038	Output mode of low load current • 00 Disabled • 01 During accel, decel and constant speed • 02 During constant speed only		01	
C039	Low load detection level		INV Rated current	
C041/ C241	Overload output signal level setting		INV Rated current	
C042	Frequency arrival setting for accel		0.0	
C043	Frequency arrival setting for decel		0.0	
C044	PID deviation level setting		3.0	
C052	PID PV high limit		100.0	
C053	PID PV low limit		0.0	
C070	Selection of OPE/ModBus • 02 OPE • 03 ModBus		02	
C071	Communication speed selection • 04 4800bps • 05 9600bps • 06 19200bps		06/04	
C072	Node allocation		1.	
C074	Communication parity selection • 00 No parity • 01 Even parity • 02 Odd parity		00	
C075	Communication stop bit selection		1	
C076	Communication error select • 00 Trip (error code E60) • 01 Decelerate to stop and trip (error code E60) • 02 Disable • 03 Free run stop (coasting) • 04 Decelerate to a stop		02	

Func. Code	Name / Description	Default value -FEF2/-FU2	Set value
C077	Communication error time-out	0.00	
C078	Communication wait time	0.	
C081	O input span calibration	100.0	
C082	OI input span calibration	100.0	
C086	AM offset calibration	100.0	
C091	Debug mode enable • 00 No Display • 01 Display	00 <Do not change>	00
C101	Up/Down memory mode selection • 00 Clear last frequency (return to default freq. F001) • 01 Keep last freq. adjusted by Up/Down	00	
C102	Reset selection • 00 Cancel trip state at input signal ON transition, stops INV if in Run Mode • 01 Cancel trip state at input signal OFF transition, stops INV if in Run Mode • 02 Cancel trip state at input signal ON transition, no effect if in Run Mode	00	
C141	Input A select for logic output	Twelve option codes available see page 20	00
C142	Input B select for logic output		01
C143	Logic function select • 00 [LOG] = A AND B • 01 [LOG] = A OR B • 02 [LOG] = A XOR B	00	
C144	Terminal [11] ON delay	0.0	
C145	Terminal [11] OFF delay	0.0	
C148	Output relay ON delay	0.0	
C149	Output relay OFF delay	0.0	

“H” group: Motor Constants Functions

Func. Code	Name / Description	Default -FEF2/-FU2	Set value
H003/ H203	Motor capacity	Factory set	
H004/ H204	Motor poles setting • 2 • 4 • 6 • 8	4	
H006/ H206	Motor stabilization constant	100	

Intelligent Input Terminal Listing

Symbol	Code	Input Terminal Name
FW	00	Forward Run/Stop
RV	01	Reverse Run/Stop
CF1	02	Multi-speed select, Bit 0 (LSB)
CF2	03	Multi-speed select, Bit 1
CF3	04	Multi-speed select, Bit 2
CF4	05	Multi-speed select, Bit 3 (MSB)
JG	06	Jogging
DB	07	External DC braking
SET	08	Set (select) 2 nd motor data
2CH	09	2-stage accel and decel
FRS	11	Free-run stop
EXT	12	External trip
USP	13	Unattended start protection
SFT	15	Software lock
AT	16	Analog input voltage/current selection
RS	18	Reset inverter
PTC	19	PTC thermistor thermal protection
STA	20	Start (3-wire interface)
STP	21	Stop (3-wire interface)
F/R	22	FWD,REV (3-wire interface)
PID	23	PID disable
PIDC	24	PID Reset
UP	27	Remote control Up function
DWN	28	Remote control Down function
UDC	29	Remote control data cleaning
OPE	31	Operator control
ADD	50	Add frequency enable
F-TM	51	Force Terminal Mode
RDY	52	Inverter ready
SP-SET	53	Special set
EMR	64	Safe stop
-	255	(No function)

Intelligent Output Terminal Listing

Symbol	Code	Output Terminal Name
RUN	00	Run signal
FA1	01	Freq. arrival type 1 – constant speed
FA2	02	Freq. arrival type 2 – over-frequency
OL	03	Overload advance notice signal
OD	04	Output deviation for PID control
AL	05	Alarm signal
Dc	06	Analog input error
FBV	07	PID second stage output
NDc	08	Network error
LOG	09	Logic output function
ODc	10	Communication option error
LOC	43	Low load detection

Analog Input Configuration

The following tables show the parameter settings required for various analog input signal types.

A005	02		03		04		05	
AT input	OFF	ON	OFF	ON	OFF	ON	OFF	ON
Active	[O]	POT	[OI]	POT	[O]		[OI]	

If [AT] is not assigned to any intelligent input terminal, it means AT=OFF in above table.



Note: Analog input O and OI cannot be used at the same time.

Analog Output Function Listing

The following table shows all three functions available for assignment to the analog output terminal:

- Terminal [AM], option set by C028

Option Code	Function Name	Description	Corresponding Signal Range
00	Output frequency	Actual motor speed, represented by PWM signal	0 to max. freq. in Hz
01	Output current	Motor current (% of maximum rated output current), represented by PWM signal	0 to 200%

UL® Cautions, Warnings, and Instructions

Wiring Warnings for Electrical Practices and Wire Sizes

The warnings and instructions in this section summarize the procedures necessary to ensure an inverter installation complies with Underwriters Laboratories® guidelines.



WARNING: “USE 60/75°C Cu wire only” or equivalent. For models X200-005S, -007S, -011S, -022S, -007N, -015N, -015L, -022L, -037L, -055L, -075L.



WARNING: “USE 75°C Cu wire only” or equivalent. For models X200-002S, -004S, -002N, -004N, -002L, -004L, -007L, -022H, -030H, -037H, -040H, -055H, 075H.



WARNING: “USE 60°C Cu wire only” or equivalent. For models X200-004H, -007H, and -015H.



WARNING: “Open Type Equipment”



WARNING: “Suitable for use on a circuit capable of delivering not more than 100k rms symmetrical amperes, 240V maximum when protected by Class CC, G, J or R fuses or circuit breaker having an interrupting rating not less than 100,000 rms symmetrical amperes, 240 volts maximum”. For models with suffix S, N or L.



WARNING: “Suitable for use on a circuit capable of delivering not more than 100k rms symmetrical amperes, 480V maximum when protected by Class CC, G, J or R fuses or circuit breaker having an interrupting rating not less than 100,000 rms symmetrical amperes, 480 volts maximum.” For models with suffix H.



WARNING: “Install device in pollution degree 2 environment.”



WARNING: “Maximum Surrounding Air Temperature 50°C”. or equivalent.



WARNING: “Caution-Risk of electric shock—capacitor discharge time is at least 5 minutes.”



WARNING: “Solid state motor overload protection is provided in each model”.



WARNING: “Integral solid state short circuit protection does not provide branch circuit protection. Branch circuit protection must be provided in accordance with the National Electric Code and any additional local codes” or equivalent.

Terminal Tightening Torque and Wire Size

The wire size range and tightening torque for field wiring terminals are presented in the tables below.

Input Voltage	Motor Output		Inverter Model	Power Terminal Wiring Size Range (AWG)	Torque	
	kW	HP			Ft-lbs	(N·m)
200V	0.2	1/4	X200-002SF2/NFU2	14 (75°C only)	0.6	0.8
	0.4	1/2	X200-004SF2/NFU2			
	0.55	3/4	X200-005SF2			
	0.75	1	X200-007SF2/NFU2	12	0.9	1.2
	1.1	1 1/2	X200-011SF2			
	1.5	2	X200-015SF2/NFU2			
	2.2	3	X200-022SF2/NFU2	10	0.9	1.2
	3.7	5	X200-037LFU2	10		
	5.5	7 1/2	X200-055LFU2	8		
7.5	10	X200-075LFU2				
400V Class	0.4	1/2	X200-004HF2/HFU2	16 (75°C only)	0.9	1.2
	0.75	1	X200-007HF2/HFU2			
	1.5	2	X200-015HF2/HFU2			
	2.2	3	X200-022HF2/HFU2	14 (75°C only)	2.3	3.0
	3.0	4	X200-030HF2			
	4.0	5	X200-040HF2/HFU2			
	5.5	7 1/2	X200-055HF2/HFU2	10	2.3	3.0
	7.5	10	X200-075HF2/HFU2			

Terminal Connector	Wiring Size Range (AWG)	Torque	
		Ft-lbs	(N·m)
Logic and Analog connectors	30 – 16	0.16 – 0.19	0.22 – 0.25
Relay connector	30 – 14	0.37 – 0.44	0.5 – 0.6

Wire Connectors



WARNING: Field wiring connections must be made by a UL Listed and CSA certified ring lug terminal connector sized for the wire gauge being used. The connector must be fixed using the crimping tool specified by the connector manufacturer.

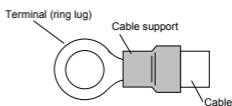

Circuit Breaker and Fuse Sizes

The inverter's connections to input power for 400V class units must include UL Listed inverse time circuit breakers with 600V rating, or UL Listed fuses as shown in the table below.

Input Voltage	Inverter Model	Circuit breaker / Fuse	Ampere rating for Fuse or Breaker	
Single/ Three- Phase 200V	X200-002SFEF2/NFU2	Inverse time circuit breaker	10	
	X200-004SFEF2/NFU2			
	X200-005SFEF2			
	X200-007SFEF2/NFU2		15	
	X200-011SFEF2			
	X200-015SFEF2/NFU2			
	X200-022SFEF2/NFU2			
	X200-037LFU2			30
	X200-055LFU2			40
X200-075LFU2	50			
Three- Phase 400V	X200-004HFEF2/HFU2	Distribution Fuse (Class J)	3	
	X200-007HFEF2/HFU2		6	
	X200-015HFEF2/HFU2		10	
	X200-022HFEF2/HFU2		10	
	X200-030HFEF2		15	
	X200-040HFEF2/HFU2		15	
	X200-055HFEF2/HFU2		20	
	X200-075HFEF2/HFU2		25	

Motor Overload Protection

Hitachi X2002 inverters provide solid state motor overload protection, which depends on the proper setting of the following parameters:

- B012 “electronic overload protection”
- B212 “electronic overload protection, 2nd motor”

Set the rated current [Amperes] of the motor(s) with the above parameters. The setting range is $0.2 * \text{rated current}$ to $1.0 * \text{rated current}$.



WARNING: When two or more motors are connected to the inverter, they cannot be protected by the electronic overload protection. Install an external thermal relay on each motor.