

HITACHI
Inspire the Next

Coding & Marking Solutions

CO2 Laser Coder

LM Series





CO2 Laser Coder LM C-301 Series

A robust, versatile, high-performance laser for industrial coding requirements

The new LM Series from Hitachi is a Carbon Dioxide CO2 based Vector laser. Our wide ranging of wavelengths as well as the flexible power and focal lens configuration ensures performance ideally suited to coding on various packaging substrates including paper, cardboard, glass or plastics. An innovative cascading cover design supported by an efficient cooling air stream provides a high level of reliability.

The result is a very low electrical energy consumption and precise, clear coding even at small font sizes. Small outer dimensions and powerful on-board control system enable easy hardware and software integration of the LM series into factory networks.





Our highlights

- Compact single body space saving design for ease of mechanical integration
- An electrical power consumption of <300 VA reduces the overall operating costs to a minimum
- Low laser power and duty cycle translates to increased reliability and increased safety due to low operating temperatures
- Lens air flow available to keep the focal lens in a clean condition
- User-friendly interface: PC based or with an optional colour 10" Touchscreen
- Highest print quality at a variety of production speeds using vector as well as Dot Matrix fonts with a user friendly font editing tool
- The beam expander technology creates a very small spot size transferring a high level of energy onto the substrate resultant in a high resolution print
- Powerful Windows software available for networking, status control and for designing the text layout with True Type fonts, barcodes & 2D codes and logo files
- Wavelengths of 9.3 μ m, 10.2 μ m and 10.6 μ m combined with various lens options allows for coding onto a wide range of substrates

Easy Operation



The user friendly colour 10" touch screen is ready for immediate use



Intuitive operation

Our new, icon-based 10" full colour touch screen provides easy and straightforward navigation. The WYSIWYG design provides stress-free operation by displaying marking data and settings immediately.

Control with standard PC equipment

The LM Series can also be operated with standard PC equipment. The windows based laser application supports multiple text layers, secure image storage operations, preview image before downloading, manage and download the laser setup for individual products and provides WYSIWIG image design. Additional features include database connectivity, an easy to use a font editor, dynamic time and date calculations, management of log files and creation of reports. By utilizing the Laser Application Software, no touch screen is needed to fully operate the laser.

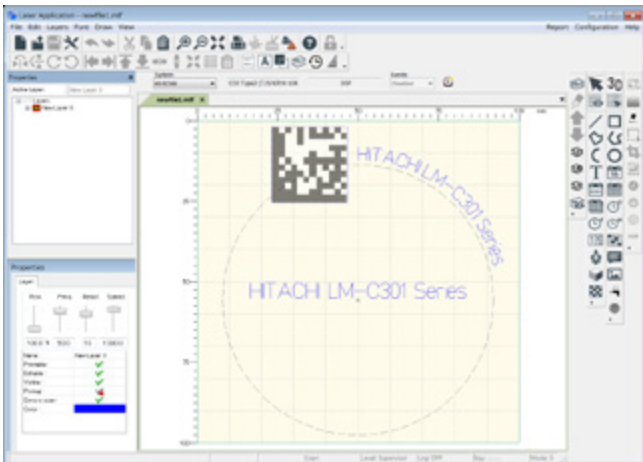

Guide laser feature [Option]

By scanning the red guide laser, the print contents and the print positions can be checked on the object.



Pointer feature [Option]

The red laser pointer makes it easy to check the center of the print.





Integration of different coding equipment

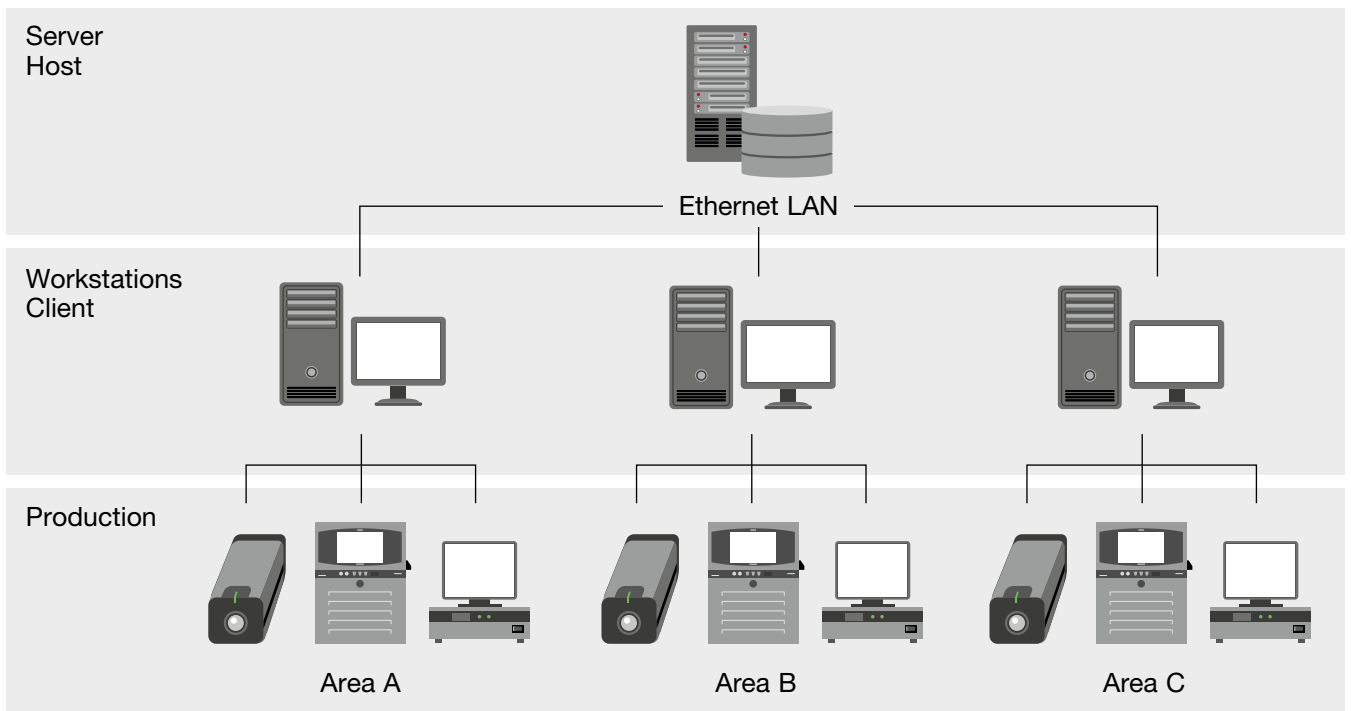

Offline configuration

Data can be created and saved via a remote PC and then transferred into the laser coder located at a remote site. The Ethernet and serial USB port of the laser coder offers a convenient way to share image files or machine settings between the laser coder and the host PC. A quick backup of the most important data is ensured and further ease operation with the LM-C301 Series.

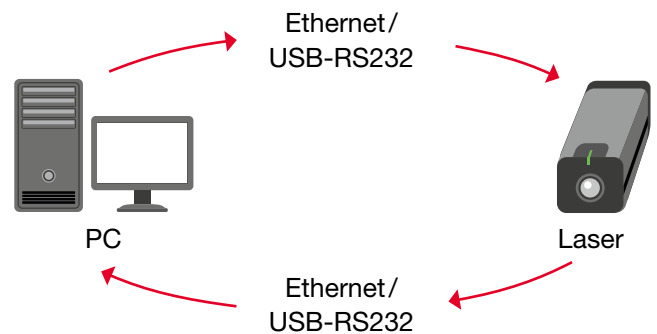

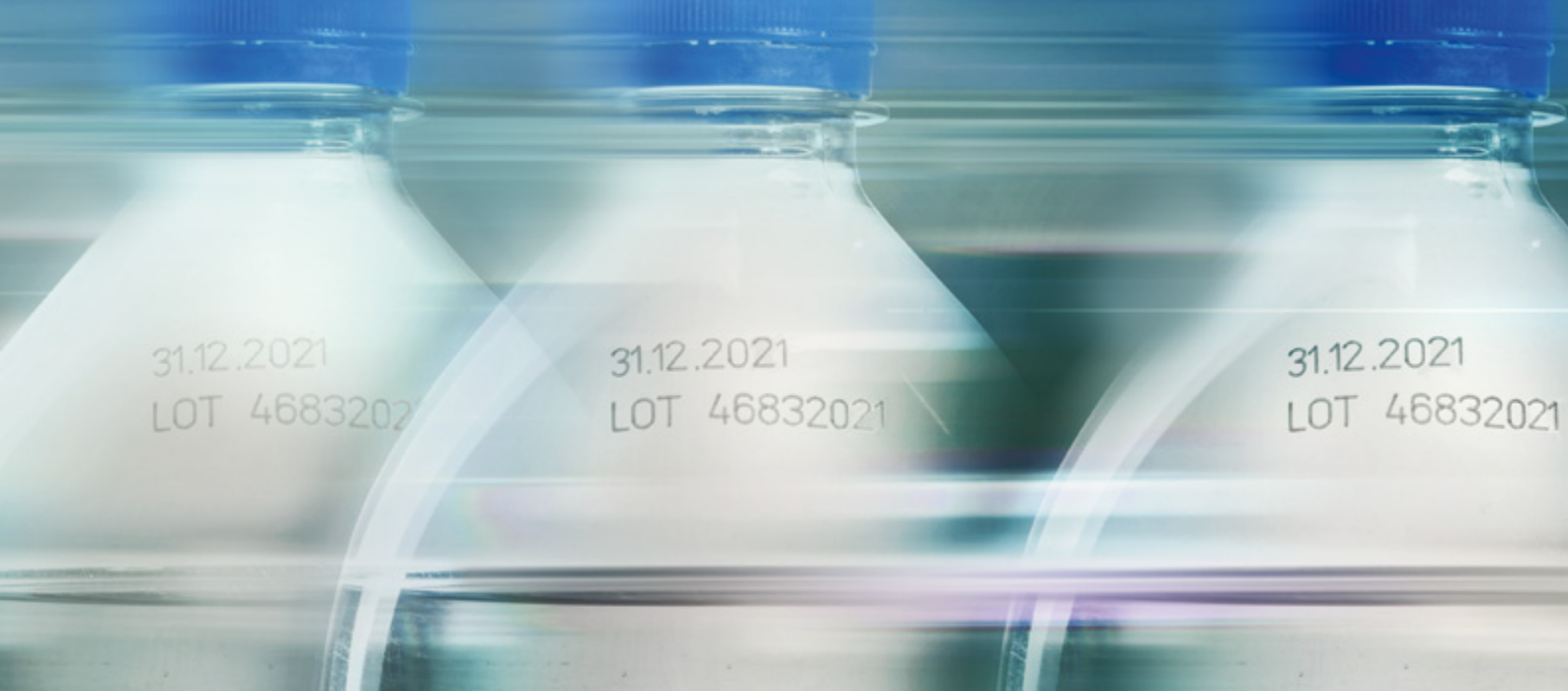

Speed & Quality



Accurate coding at high speed

Even at high speed the LM-C301 Series maintains an accurate and aligned coding process. The new laser generates energy instantaneously and transmits it onto the product in a very short time. The beam expander technology further reduces the focal point



and generates extremely sharp and clear characters and vector lines onto the packaging material. Even though the LM-C301 Series is a vector font based laser, dot matrix fonts can be printed on demand as well.

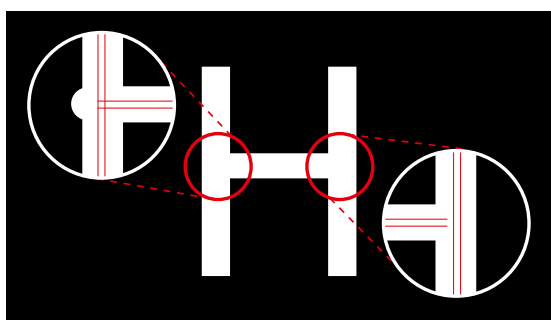

Intersection correction

Our LM-C301 Series offers a support function for crossless lines, which prevents deep marking where lines intersect, eliminating the tendency of overlapping lines not to distort the shape of output characters. These crossless fonts have been engineered and designed by the powerful font editing tool which is available as part of the laser application software.



The font editor

Each character of a font can be manually modified and aligned to the application requirements. True type fonts and laser fonts can be opened and changed plus some areas of an image might require a deeper and more powerful marking than others. In order to prevent pin holes, the individual character line can be interrupted at any point. The package keeps its consistency and the product is safely protected.

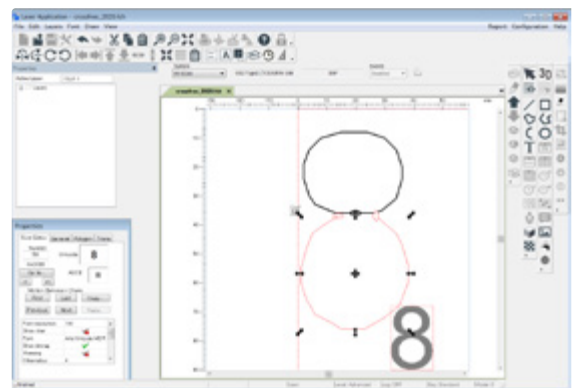

High speed coding at 600 cps

Hitachi's new laser is capable of printing up to 600 characters per second (cps). This high performance scribing process can be achieved through the use of a new dynamic and precise optic assembly. The overall weight of all moving parts has been reduced to a minimum which results in a faster marking time. The edges of each character remains correctly marked with no degradation of the character form despite the high speed.

Depth control

The LM-C301 Series offers many system settings which control the power of the marking at areas susceptible to deep marking such as beginning and end of lines where straight and curved lines intersect. Unwanted dots or even missing lines are being prevented. The dynamic depth control also removes less material from the product package and therefore extends the filter life time of the fume extraction system.

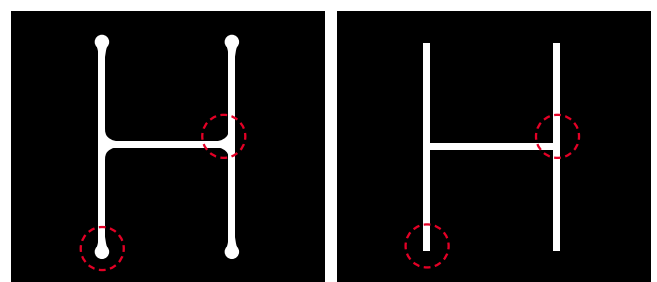
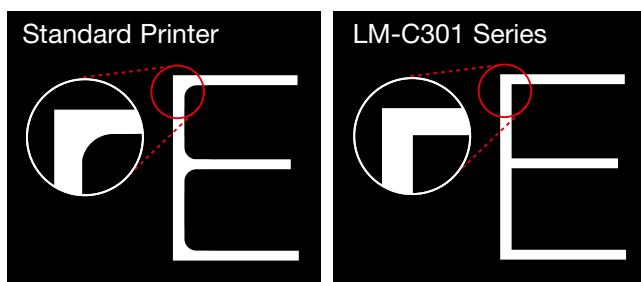

Proven Reliability & Safety

Cooling System

Low power air cooled laser systems are the only compact laser technologies demanding less floor space and providing ease of mechanical integration into complex packaging lines.

The new cascading cover design and enclosed optical box protect electronics and optics from dust and leads to a high level of reliability of electronics and optics.

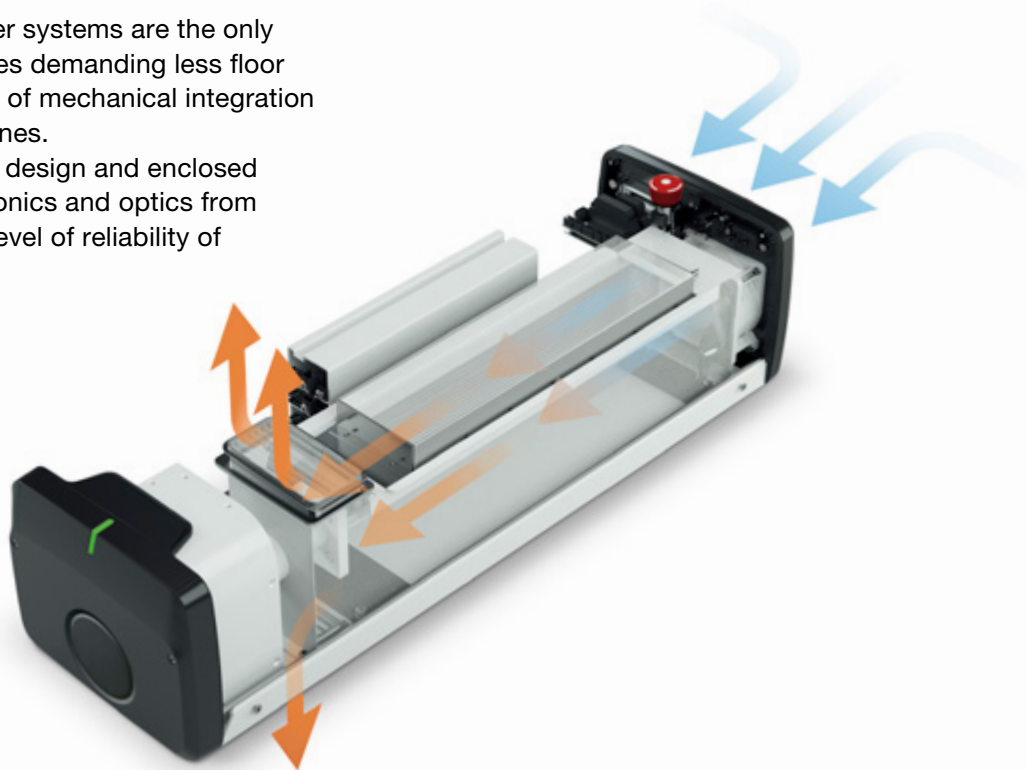

Lens air flow

The innovative air flow helps to keep the focal lens in a clean condition (when installed at 90 deg.). The overpressure helps in keeping any kind of particulate off the lens assembly, avoids contamination and any reduction of laser output power. This helps to reduce operating costs, minimizes maintenance and increases print quality.

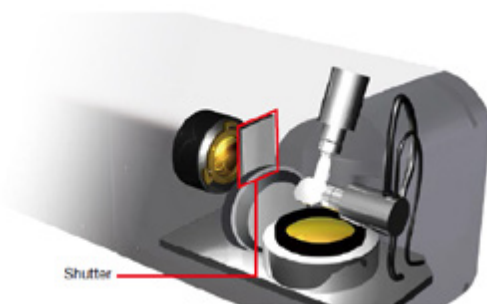
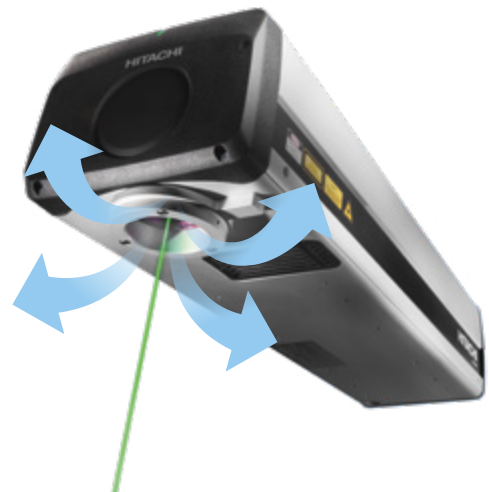

Shutter

The electromechanical shutter effectively blocks the laser beam and prevents optical radiation from being emitted. The reliable design ensures high safety performance.

Laser status indicator

Three-color laser status indicator is adopted on the head of laser marker. Using this indicator, it is possible to monitor the status of the laser system at a single glance.



Ready
[Green]



Marking
[Blue]



Alarm
[Orange]

Harsh environment

With the robust structure which provides a high level of protection for the laser tube and optics, the new LM Series can be used in extremely harsh production environments and meets IP54 accreditation. Less regular cleaning of the mirrors and the lens assembly means reduced operator intervention, further reducing running costs.



Global sales & service network

Are you looking for a proven global company that can work with you at a local level? Hitachi offers a global sales and service network when marking, coding and traceability challenges demand a coordinated answer. For each of your locations, and across your entire organization we will champion your goals by providing international consistency, global perspective, broad expertise and coordinated service with dedicated contacts. Our global team applies its worldwide technical

expertise to your unique challenges in a consistent way. Tangible deliverables and proven solutions are results of our business analysis and project implementation. Mechanical integration is supported by 3D CAD design, electrical schematics, customized circuits, application specifications and customized documents. Plus cross border project management and coordination between suppliers, OEM's and end users are part of our deliveries. You gain more visibility and save time and money.

Packaging materials

The world of packaging consists of a huge variation of different technologies and materials including paper, corrugated cardboard, glass, rigid plastics, flexible foils and films to name a few. To handle this diversity of materials Hitachi's LM-C301 Series comes with two different output power levels – 10W and 30W – and with three different wavelengths: 9.3µm, 10.2µm and 10.6µm. Remember each material and composition does adopt, absorb and reflect light in a different way.



PET – 9.3µm Wavelength

Perfectly matched for the head absorption of plastics like PET (Polyethylene Terephthalate), the 9.3µm wavelength laser allows marking on plastic surfaces by smoothly melting the surface layer without creating pinholes or cracking the inner structure. This is the ideal solution for plastics being produced by polycondensated thermoplastic materials from the family of polyesters. PET is widespread in the beverage industry and is mostly used for producing bottles.



Film and Foil – 10.2µm Wavelength

The 10.2µm wavelength is ideally suited to marking on thin films and any type of packaging foil. Best results can be expected on painted films and foils with a thin ink layer on top. The laser energy removes the ink and generates a contrast to the next bottom layer e. g. to the metalized composite or aluminium. Packaging materials which absorb this wavelength very well and therefore generates best CO2 Laser print quality are PE, HDPE, LDPE, PP, OPP, OPA, PA, PMMA, POM, PUR, ABS and PVC.



Paper, cardboard and glass – 10.6µm Wavelength

The CO2 laser radiation of 10.6µm wavelength gets well absorbed in applications that process materials ranging from thin paper to cardboard type packaging. Extremely good print results are also achieved on any kind of glass products. This wavelength is the most common one available with CO2 lasers and perfectly suits the majority of packaging applications.

Specifications

	LM-C301S (Without Beam Expander)		LM-C301P (With a Beam Expander)	
Model	LM-C331S	LM-C311P	LM-C331P	
Laser Technology	CO2 Laser, Class 4 laser			
Laser Power & Laser Wavelength	30 W 10.6 μm (e. g. Paper, Cardboard, Glass)	10 W 10.6 μm (e. g. Paper, Cardboard, Glass)	30 W 10.6 μm (e. g. Paper, Cardboard, Glass) 25 W 10.2 μm (e. g. OPP, PP, PE) 20 W 9.3 μm (e. g. PET)	
Marking Area (mm) *1	40 × 40 60 × 60 *2 75 × 75 100 × 100	10.6 μm: 40 × 40 60 × 60 75 × 75 100 × 100*2 150 × 150 200 × 200 250 × 250	10.2 μm: 40 × 40 60 × 60 75 × 75 100 × 100 150 × 150 200 × 200 250 × 250	9.3 μm: 60 × 60 75 × 75 100 × 100
Guide Laser, Pointer (Options)	Red semiconductor, Wavelength 655 nm, Class 2 Laser			
User Interface	Touch Screen (Option) / Laser Marker Application PC Software (Option)			
Shutter	Electromechanical Shutter			
Protection	IP 54			
Weight	22 kg	18 kg	22 kg	
Dimension (Width × Height × Depth)	216 × 179 × 747 (mm)	196 × 148 × 728.5 (mm)	216 × 179 × 747 (mm)	
Laser Status Indicator	Ready (Green) / Marking (Blue) / Alarm (Orange)			
Power Supply	AC100 to 120 V ± 10 %, AC200 to 240 V ± 10 % (50 / 60 Hz)			
Power Consumption	600 VA	300 VA	600 VA	
Operating Temperature Range	5 to 40 °C (No dew condensation or freezing allowed.)			
Operating Humidity Range	35 to 95 % RH (No dew condensation or freezing allowed.)			

*1 Vary corresponding lens with the wavelength

*2 Recommended models

Global standards

- Conformity to global standards
CE, UL, c-UL approvals.



Dimensions of Laser (mm)

LM-C311P

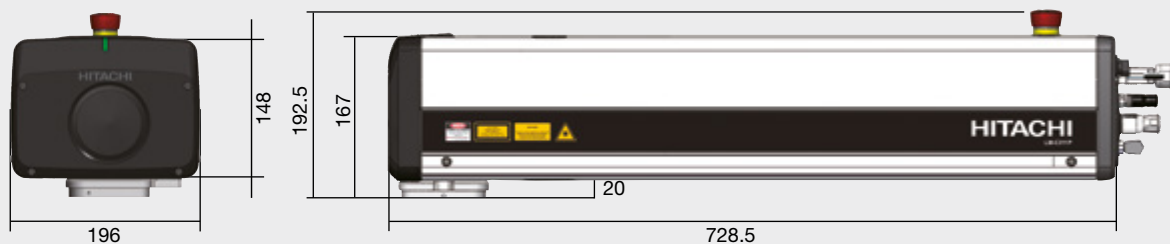

LM-C331S, LM-C331P

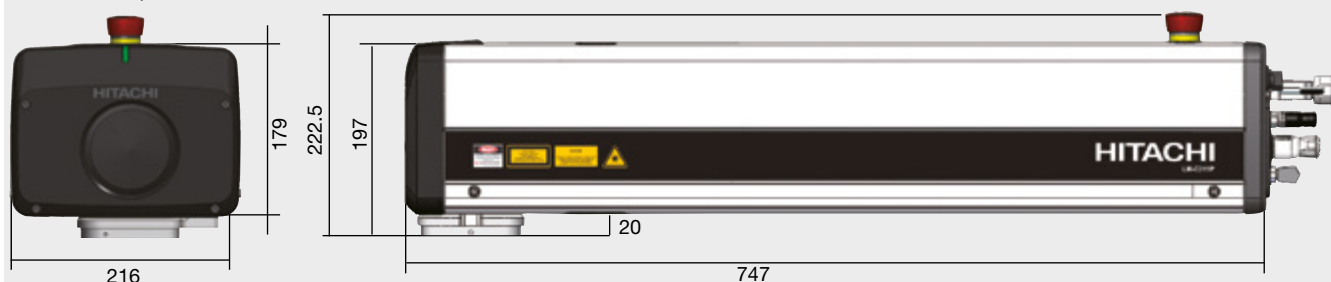

Head Office

Japan

Hitachi Industrial Equipment Systems Co., Ltd.
Phone: +81 3 4345 6000
www.hitachi-ies.co.jp
info@hitachicoding.com

Sales Offices

America

Hitachi Industrial Equipment & Solutions America, LLC
Phone: +1 866 583 0048
www.hitachi-iesa.com/marking
Marking.Info@hitachi-iesa.com

Asia

Hitachi Asia Ltd.
Phone: +65 6305 7400
www.hitachi.com.sg/ice

China

Hitachi Industrial Equipment Systems (China) Co., Ltd.
Phone: +86 21 5489 2378
www.hitachi-iec.cn

Europe

Hitachi Europe GmbH
Phone: +49 211 5283 0
www.hitachi-industrial.eu
info@hitachicoding.com

Oceania

Hitachi Australia Pty Ltd.
Phone: +61 2 9888 4100
www.hitachi.com.au/products

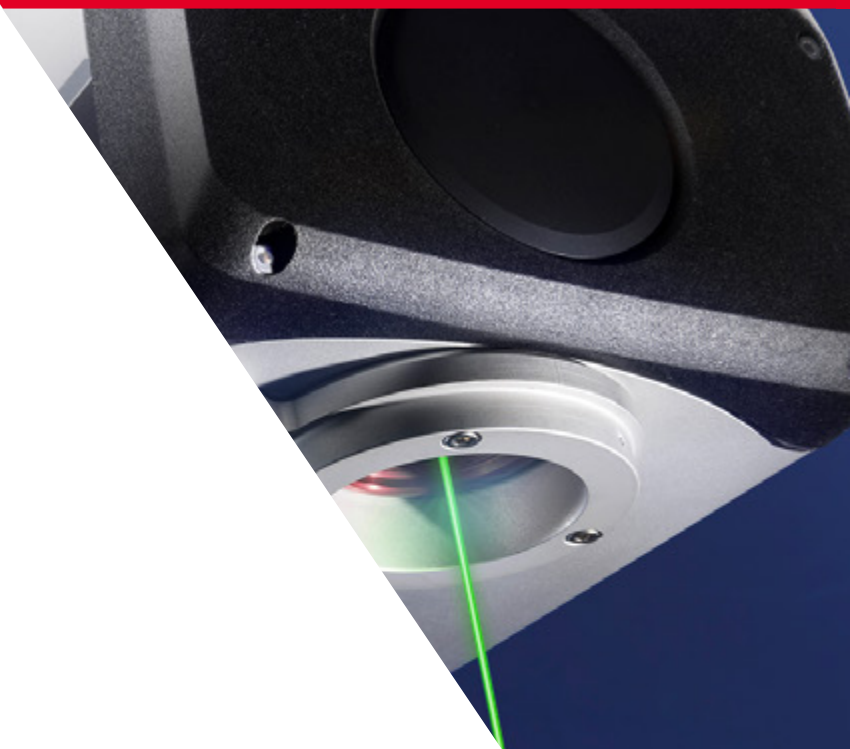

Follow us:



All company and product names in this brochure are the property of the respective companies.